















SCHMIDT-Test-Instruments
*indispensable in production monitoring,
quality control and automation*
We solve your measuring problems:

-  Tension Meter
-  Force Gauge
-  Torque Meter
-  Tachometer
-  Speed- and Lengthmeter
-  Electronic Lengthmeter
-  Stroboscope
-  Screen Printing Tension Meter
-  Thickness Gauge
-  Yarn Package Durometer and Shore-A Durometer
-  Sample Cutter
-  Balance
-  Moisture Meter
-  Leak Tester
-  Softometer

More than 70 years - Worldwide -

Hans Schmidt & Co GmbH

Mailing address:
P. O. B. 1154
84464 Waldkraiburg Germany
Shipping address:
Schichtstr. 16
84478 Waldkraiburg Germany

Phone:
int. + 49 / (0)8638 / 9410-0
Fax:
int. + 49 / (0)8638 / 4825
int. + 49 / (0)8638 / 67898

HCL
Apparel Instruments
www.hcl-asia.com.hk
Est. 2001

Tension Meter

Z Series

Model ZF2



Operating Instructions

Valid as of: 01.02.2007 • Please keep the manual for future reference!

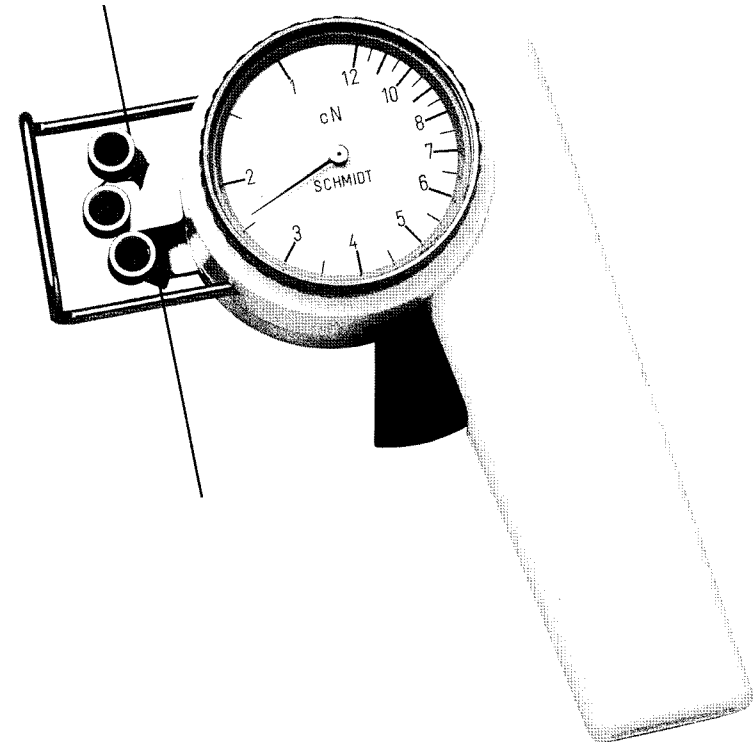

Distributed By:



HCL Asia Ltd.

Unit 14, 6/F., Worldwide Industrial Centre,
43-47 Shan Mei Street, Fotan, Shatin, Hong Kong
T: +852 27420018 F: +852 27420053
info@hcl-asia.com.hk
www.hcl-asia.com.hk



Contents

1 Warranty and Liability	3
1.1 Notices within the Operating Instructions.....	3
1.2 Responsibilities of the Operating Company	3
1.3 Responsibilities of the Personnel	3
1.4 Informal Safety Measures	4
1.5 Training of the Personnel	4
1.6 Intended Use.....	4
1.7 Dangers in Handling the Device.....	4
1.8 Copyright.....	4
1.9 Declaration of Conformity.....	4
2 Available Models	5
2.1 Specifications	5
2.2 Delivery Includes	6
2.3 Unpacking	6
3 Initial Setup and Operating Procedure	6
3.1 Notes Before Starting Measurement.....	6
3.2 Operating Elements of the Tension Meter	7
3.3 Measuring with the Tension Meter	7
3.4 Checking the Measuring Accuracy.....	8
4 Service and Maintenance	9
4.1 Rollers	9
5 Cleaning	9
6 Verification Intervals	9
7 Verification of Calibration and Determination of Repair Costs	10
8 Correspondence	11
9 Repairs	11

1 Warranty and Liability

In principle, the supply of the device is subject to our "General Conditions of Sale and Delivery." These have been provided to the operating company on conclusion of the contract, at the latest.

Warranty:

- SCHMIDT tension meters are warranted for 12 months.

Parts subject to wear, electronic components and measuring springs are not covered by the warranty. No warranty or liability will be accepted for bodily injury or property damage resulting from one or several of the following causes:

- Misuse or abuse of the device.
- Improper mounting, commissioning, operation and maintenance of the device (e.g. verification interval).
- Operation of the device if any safeguards are defective or if any safety and protection precautions are not properly installed or not operative.
- Failure to comply with the notices in the Operating Instructions regarding transport, storage, mounting, commissioning, operation, maintenance and setup of the device.
- Any unauthorized structural alteration of the device.
- Insufficient inspection of device components that are subject to wear.
- Opening the device or improper repair work.
- Disasters caused by the effects of foreign objects or by force majeure.

1.1 Notices within the Operating Instructions

The fundamental prerequisite for the safe handling of this device and its troublefree operation is the knowledge of the basic safety notices and safety instructions.

These Operating Instructions contain the most important notices for the safe operation of the device.

These Operating Instructions, in particular the safety notices, must be observed by any person who works with the device. In addition, the local valid rules and regulations for the prevention of accidents must be complied with.

The representations within the Operating Instructions are not true to scale.

The dimensions given are not binding.

General indications of direction, such as FRONT, REAR, RIGHT, LEFT apply when viewing the front of the device.

1.2 Responsibilities of the Operating Company

In compliance with the EC Directive 89/655/EEC, the operating company agrees to only permit persons to work with the device who:

- are familiar with the basic regulations on industrial safety and accident prevention and who have been trained in handling the device.
- have read and understood the chapter on safety and the warning notices in these Operating Instructions and have confirmed this with their signatures.
- are examined regularly on their safe and conscientious working method.

1.3 Responsibilities of the Personnel

All persons who work with the device agree to perform the following duties before starting work:

- to observe the basic regulations on industrial safety and accident prevention.
- to read the chapter on safety and the warning notices in these Operating Instructions and to confirm with their signatures that they have understood them.

1.4 Informal Safety Measures

The Operating Instructions must always be kept on hand where the device is operated. Apart from the Operating Instructions, the general and local valid regulations on accident prevention and environmental protection must be provided and complied with.

1.5 Training of the Personnel

Only trained and instructed personnel is permitted to work with the device. The responsibilities of the personnel must be clearly defined for mounting, commissioning, operation, setup, maintenance, and repair. Trainees may only work with the device under the supervision of experienced personnel.

1.6 Intended Use

The device is intended exclusively to be used as a tension meter. Any other use or any use exceeding this intention will be regarded as misuse. Under no circumstances shall HANS SCHMIDT & Co GmbH be held liable for damage resulting from misuse.

The intended use also includes:

- Complying with all notices included in the Operating Instructions and observing all inspection and maintenance works.

1.7 Dangers in Handling the Device

The device was designed according to the state of the art and the approved safety standards. Nevertheless, its use may cause serious or fatal injury to the user or third persons, and/or an impairment of the device or of other material assets.

The device may only be applied:

- For its intended use in a faultless condition with regard to the safety requirements.
- Malfunctions that could impair safety must be remedied immediately.
- Personal protective equipment must be used according to the EC Directive 89/686/EEC.



The device must not be operated in potentially explosive areas and must not come into contact with aggressive substances.

1.8 Copyright

The copyright on these Operating Instructions remains with the company HANS SCHMIDT & Co GmbH.

These Operating Instructions are intended for the operating company and its personnel only. They contain instructions and notices that may only be reproduced on the prior written permission of HANS SCHMIDT & Co GmbH and under indication of the complete reference data. Violations will be prosecuted.

1.9 Declaration of Conformity

Our mechanical tension meters do not belong to the EC machinery directive 2006/42/EC and do not have a CE mark.

2 Available Models



These Operating Instructions refer to Model ZD2 of the Z Series.

The individual models of the Z Series are also available with the following modifications (customized versions):

- Special tension ranges
- Calibration for material path other than standard (vertical)
- Calibration to different units of measure, such as g

Model	Measuring Range cN	*Measuring Head Width mm	**SCHMIDT Calibration Material
ZF2-5	1 - 5	43	Faden 25 tex
ZF2-10	1 - 10	43	Faden 25 tex
ZF2-12	1 - 12	43	Faden 25 tex
ZF2-20	2 - 20	43	Faden 25 tex
ZF2-30	3 - 30	43	PA: 0.12 mm Ø
ZF2-50	5 - 50	43	PA: 0.12 mm Ø
ZF2-100	10 - 100	43	PA: 0.12 mm Ø

* Outer distance between outside guide rollers / pins

** Suitable for 95% of all applications. PA = Polyamide Monofilament.

If the material to be measured differs significant from the SCHMIDT calibration material in diameter, rigidity, shape, etc., we recommend calibration using customer supplied material. For this purpose a material sample of about 5 m should be supplied. International unit of tensile force: 1 cN = 1.02 g = 0.01 N

2.1 Specifications

Calibration:	According to SCHMIDT factory procedure
Accuracy:	± 1% full scale (FS) or ± 1 graduation on scale
Scale diameter:	54 mm
Temperature range:	10 - 45°C
Air humidity:	85% RH, max.
Housing material:	Plastic (POM)
Dimensions:	157 mm x 85 mm x 32 mm (L x W x H)
Weight net (gross):	approx. 200 g (approx. 600 g)

Guide rollers:

V-grooved	Line Speed max. m/min	Roller Material
Standard	2000	Hardcoated Aluminium Nr. R10008
Code K	3500	Hardcoated Aluminium
Code T	1000	Plastic (POM) black
Code W	1000	Nickel-plated steel

2.2 Delivery Includes

- 1 Tension meter
- 1 Certificate of Compliance with the order 2.1 under EN 10204
- 1 Operating Instruction
- 1 Carrying case

2.3 Unpacking

Unpack the tension meter and inspect it for any shipping damage. Notices of defect must be filed immediately, in writing, at the latest within 10 days on receipt of the goods.

3 Initial Setup and Operating Procedure

3.1 Notes Before Starting Measurement



Have you read and understood the Operating Instructions, in particular Chapter 1 "Basic Safety Notices" ?
You are not permitted to operate the tension meter before doing so.

Before working with the instrument you must put on your personal protective clothing, if necessary. For example, eye protectors, gloves, etc.
To avoid damage, do not move the center roller by hand.

Tensions that exceed the tension range of the instrument by more than 100% may cause permanent damage to the measuring spring and must be avoided under any circumstances.

Do not turn the outer ring of the movement, the measured values will otherwise be wrong. If the outer ring has been turned, check the calibration as described in Chapter 3.3 and correct the position of the outer ring.

i The ID plate with the serial number as well as the calibration label (optional) are provided on the rear side of the instrument, the SCHMIDT Quality Seal are provided on the front side.

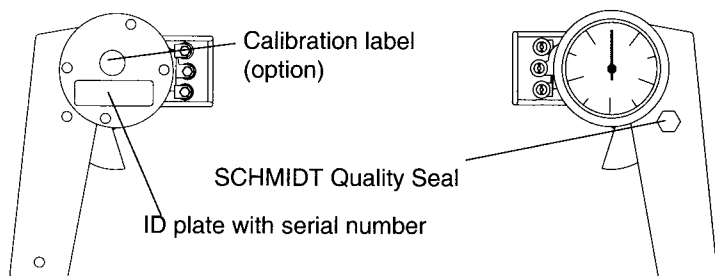

fig. 3.1

3.2 Operating Elements of the Tension Meter

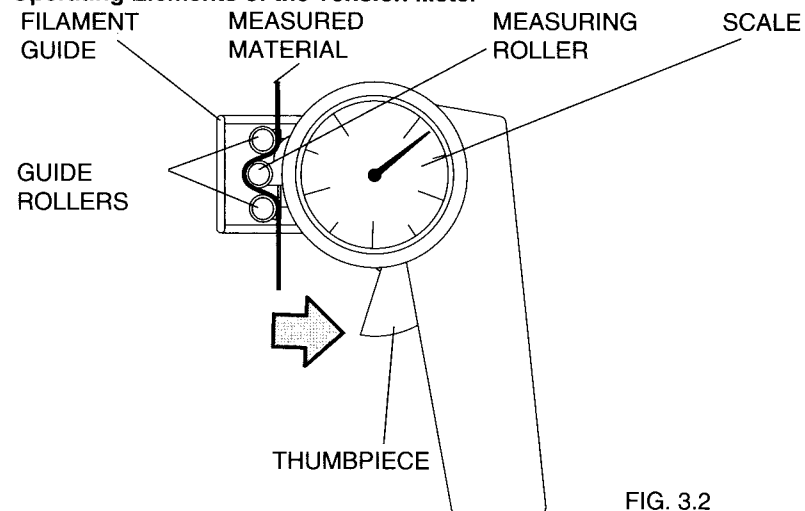

FIG. 3.2

3.3 Measuring with the Tension Meter

Inserting:

- Push the THUMBPIECE as far as it will go in the direction of the arrow to extend the GUIDE ROLLERS.
- Keeping the GUIDE ROLLERS extended, bring the instrument behind or under the filament and move it so that the GUIDE ROLLERS contact the PROCESS MATERIAL (see fig. 3.3).
- **Slowly** release pressure on the TRIGGER until the GUIDE ROLLERS return to their original position. It is important to assure that the measured material runs smoothly between the GUIDE ROLLERS and the MEASURING ROLLER.

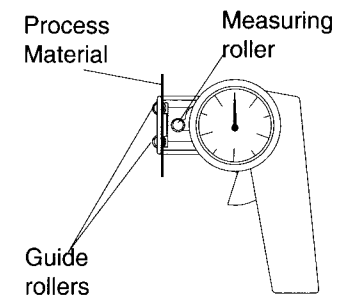

fig. 3.3



It is essential that the THUMBPIECE return slowly to its initial position. Any uncontrolled snap-back may affect calibration and may also damage the instrument.

The SCALE pointer will now show the line tension directly.

Removing:

- Push the THUMBPIECE as far as it will go in the direction of the arrow.
- With the GUIDE ROLLERS extended, move the instrument away from the material.
- Slowly release pressure on the THUMBPIECE until the GUIDE ROLLERS return to their original position.



It is essential that the thumbpiece return slowly to its initial position. Any uncontrolled snap-back may affect calibration and may also damage the instrument.

3.4 Checking the Measuring Accuracy

All tension meters are calibrated with standard materials - such as polyamide monofilament (PA) - according to the SCHMIDT factory procedure. The filament sizes are noted in Chapter 2. Any difference in process material size and rigidity from the standard material may cause a deviation of the accuracy. In 95 % of all industrial applications the SCHMIDT calibration has been proven to provide the best results and is used for comparative purposes. If the process material differs significant in size, rigidity and shape we recommend special calibration using customer's sample. For this purpose a material sample of 5 m should be supplied.

Checking procedure:

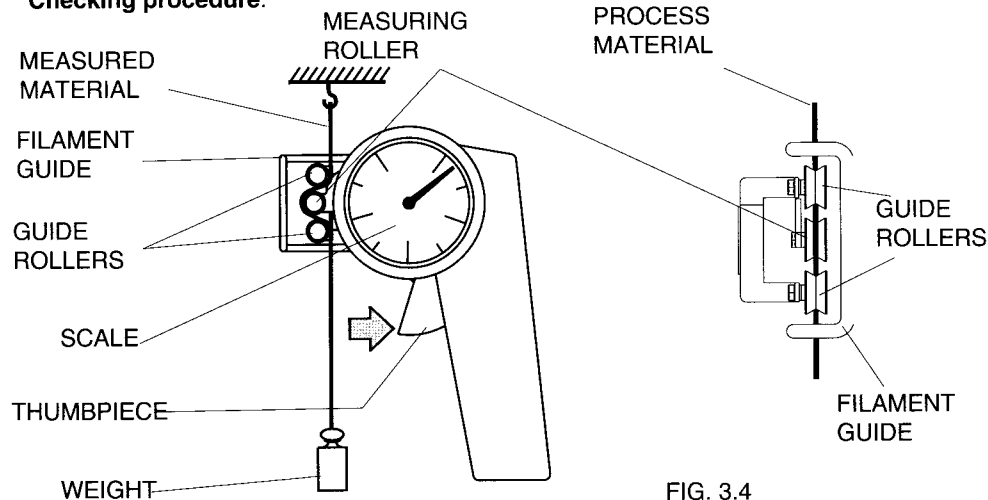

FIG. 3.4

- Suspend a known WEIGHT that corresponds to the tension to be measured (pay attention to the correct unit of measure) from the PROCESS MATERIAL, vertically, as shown in fig. 3.4. (Always use a fresh portion of the material to be measured).
- Push the THUMBPIECE as far as it will go in the direction indicated by the arrow and thread the material to be measured between the GUIDE ROLLERS and the MEASURING ROLLER. Refer to Chapter 3.2
- Slowly release pressure on the THUMBPIECE until the GUIDE ROLLERS return to their original position.



It is essential that the THUMBPIECE return slowly to its initial position. Any uncontrolled snap-back may affect calibration and may also damage the instrument.

- Before the final check, move the instrument slowly up and down to compensate any friction caused by the instrument and thus ensure the repeatability.
 - The tension value should be equal to the value of the suspended WEIGHT.
- If this procedure shows a deviation beyond the allowable tolerance and a reliable operation is no longer allowed, the instrument has to be recalibrated or repaired. For recalibration, return the tension meter to the factory.

4 Service and Maintenance

The tension meter is easy to maintain. Depending on operating time and load, the tension meter should be checked according to the locally valid regulations and conditions (as described in Chapter 3.4). The use of other test methods than the procedure described in Chapter 3.4 may cause deviating measuring results.

4.1 Rollers

You should regularly inspect the rollers to assure that they are running easily and smoothly. You can replace the rollers yourself, as necessary. In such a case, please indicate the tension meter model and the serial number (given on the rear side of the tension meter) in your spareparts order.

For example:

Order of spare rollers:

- | | | |
|-------------------|--|------------------------------------|
| Model: | ZF2-12 | (on the rear of the tension meter) |
| Serial number: | 211 - 888888 | (on the rear of the tension meter) |
| Standard rollers: | Order number R521105 | |
| Supply: | 1 set (3 pieces) spare rollers 900 m/min with mounting wrench | |
| or | | |
| Model: | ZF2-12-K | (on the rear of the tension meter) |
| Serial number: | Z 211 - 888888 | (on the rear of the tension meter) |
| Roller Code K: | Order number R521106 | |
| Supply: | 1 set (3 pieces) spare rollers 2000 m/min with mounting wrench | |

5 Cleaning

For cleaning the unit, do not use any



AGGRESSIVE SOLVENTS

such as trichloroethylene or similar chemicals.



NO WARRANTY OR LIABILITY

shall be accepted for damage resulting from improper cleaning.

6 Verification Intervals

The question of finding the right frequency of calibration accuracy verification depends on several different factors:

- Operating time and load of the SCHMIDT tension meter
 - Tolerance band defined by the customer
 - Changes of the tolerance band compared to previous verifications of calibration
- Therefore, the interval between verifications must be determined by the user's Quality Assurance Department based on the user's experience. Assuming normal operating time and load as well as careful handling of the tension meter, we recommend a verification interval of 1 year.

7 Verification of Calibration and Determination of Repair Costs

Flow chart for verifying the calibration of used tension meters, incoming and outgoing verification with Inspection Certificate 3.1 according to DIN EN 10204

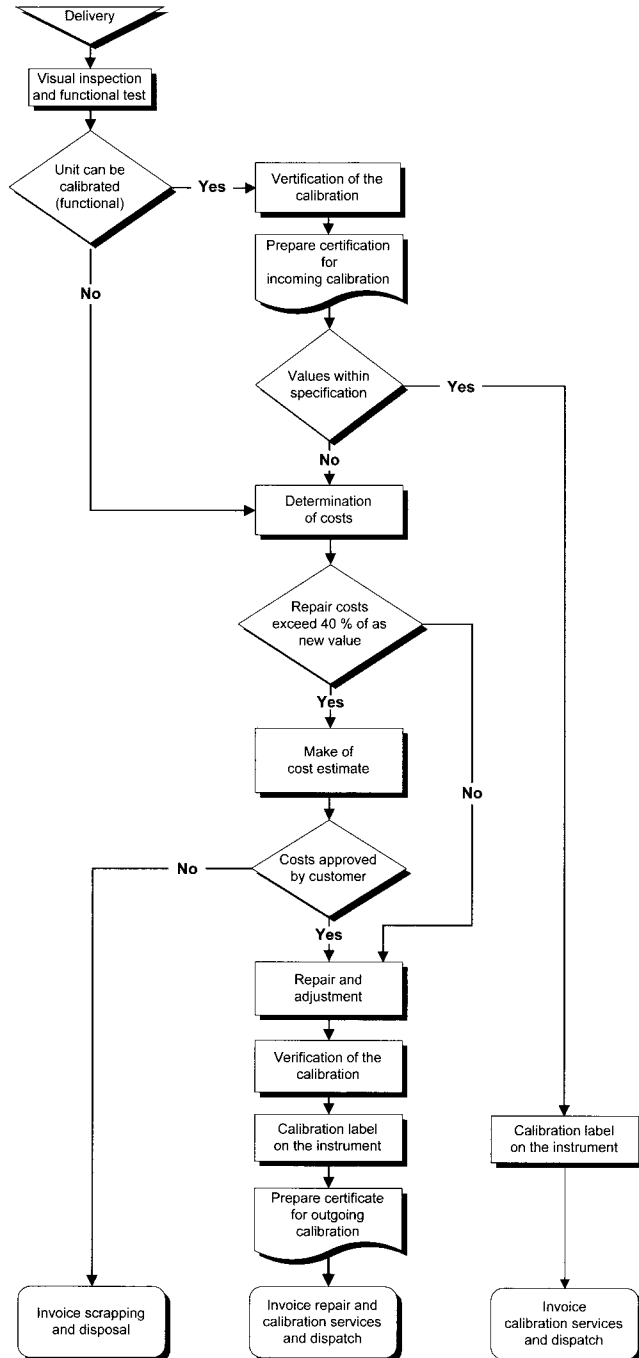

8 Correspondence

Should you have any questions regarding the instrument or Operating Instructions, or their use, please indicate above all the following details which are given on the ID plate:

- 1) Model
- 2) Serial number

9 Repairs

Shipping instructions:

We kindly ask for return free of charge for us, if possible by airmail parcel. All occurring charges, if any (such as freight, customs clearance, duty etc.), will be billed to customer. For return from foreign countries, we ask you to include a proforma invoice with a low value for customs clearance only, e.g. 50 Euro, each and to advise the shipment in advance by fax or eMail.

i To avoid unnecessary follow-up questions, and the resulting loss of time or possible misunderstandings, please return the instrument with a detailed fault description to our service department. Please indicate in your order whether you require an Inspection Certificate 3.1 according to DIN EN 10204.

Service address:

HANS SCHMIDT & Co GmbH
Schichtstr. 16
D-84478 Waldkraiburg
Germany

Distributed By:



HCL Asia Ltd.

Unit 14, 6/F., Worldwide Industrial Centre,
43-47 Shan Mei Street, Fotan, Shatin, Hong Kong
T: +852 27420018 F: +852 27420053
info@hcl-asia.com.hk
www.hcl-asia.com.hk

Notes:
